

A



ISOLATE MAINS SUPPLY BEFORE COMMENCING INSTALLATION



- Round - cut an ø81 mm circular hole at the desired location using a suitable holesaw.
- Square - cut an 81 mm by 81 mm square hole at the desired location.
- Twin - cut a 145 mm by 81 mm rectangular hole at the desired location
- Triple - cut a 213 mm by 81 mm rectangular hole at the desired location

B

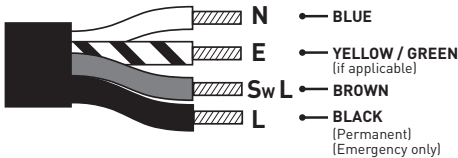

- Connect the luminaire to the mains supply using a terminal block (not supplied) compliant with the requirements of EN60998-2-1 or 2-2.

C

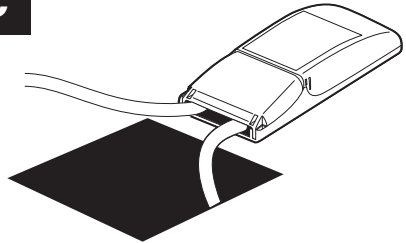

- Feed the driver(s) into the ceiling void, ensuring it is not covered by any debris or insulating material and is correctly positioned.

D

Note:
Luminaire style may vary

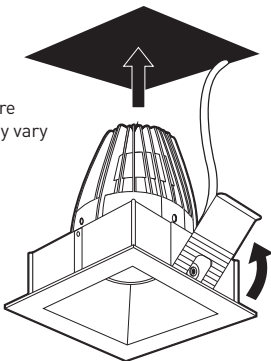

- Squeeze in ceiling springs and push the luminaire up into the ceiling void.

- Once in place make sure the luminaire is secure in ceiling.

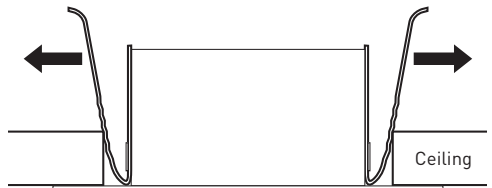

REINSTATE MAINS SUPPLY

INSTALLATION GUIDE:

PLASTER-IN LED DOWNLIGHT

IMPORTANT:

The luminaire must not be covered by any debris or insulating material. Ensure there is a minimum of 50 mm airspace around the luminaire and control gear. Electrical termination must be carried out by a qualified electrician in accordance with the latest edition of IEE wiring regulations BS7671.



NOTE: THE LED MODULES IN THIS LUMINAIRE ARE NON-USER REPLACEABLE.

PLEASE RETAIN THIS GUIDE FOR FUTURE REFERENCE AND RECYCLE PACKAGING.

A



ISOLATE MAINS SUPPLY BEFORE COMMENCING INSTALLATION

- Round - cut an $\varnothing 81$ mm circular hole at the desired location using a suitable holesaw.
- Square - cut an 81 mm by 81 mm square hole at the desired location.

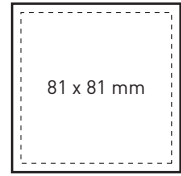
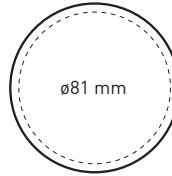

B

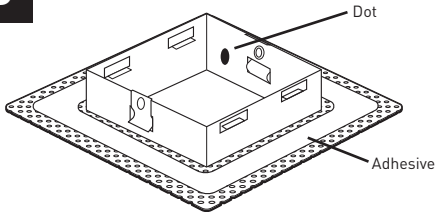

IMPORTANT: When installing wall wash type luminaires, the plaster in frame must be installed with the dot facing the wall to be illuminated.

- 1 Apply a bead of quick drying grip adhesive (not supplied) to the rear face of the frame.
- 2 Locate into hole.
- 3 Secure frame into hole using suitable screws or nails (not supplied).
- 4 Once adhesive has cured, apply PVA bonding coat and plaster up to edge of frame.
- 5 Apply finish to ceiling and allow to dry.

C

IMPORTANT - Do not install the luminaire before plaster and paint is dry. Doing so may cause chemical degradation of the LED module and will invalidate the warranty.

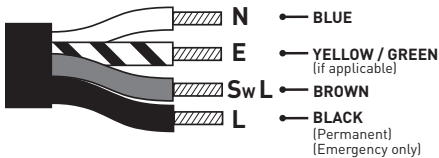

- Connect the luminaire to the mains supply using a terminal block (not supplied) compliant with the requirements of EN60998-2-1 or 2-2.
- Push the driver into the ceiling void, ensuring it is not covered by any debris or insulating material and is correctly positioned.

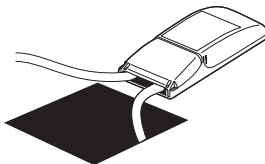

D

IMPORTANT - Align dot on luminaire to dot on frame before attempting to lock fitting in place. Failure to do so may damage the product.

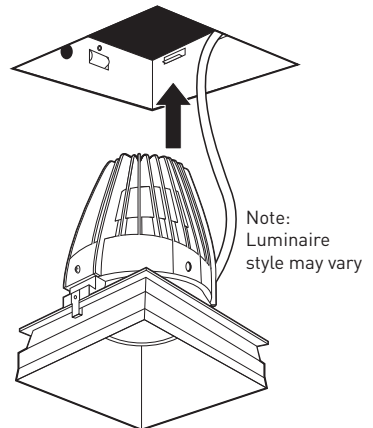

- Check the frame is clear of paint and plaster.
- Push the luminaire body into the frame.



REINSTATE MAINS SUPPLY